

## Nice Barrier gates



Nice systems to control roadways to residences, companies and communities.



**Nice**

Home Automation

Excellent reasons to choose Nice.  
Simple and practical solutions  
for any of automation.





Outdoor

For Swing Gates

Road Barriers

For Lighting Systems  
and For Irrigation Systems

**A comprehensive range and compatible systems.**

Nice offers a comprehensive range of products: a wide range of systems and products for the automation of gates, garages, shutters, barriers, awnings, shutters and now also alarm systems. All products are compatible with one another and easily integrated with existing systems.

**Design**

Today, Nice products are exhibited in design and applied art museums, and were presented with an awards at the XIX Compasso d'Oro, the most important international event in the design field.

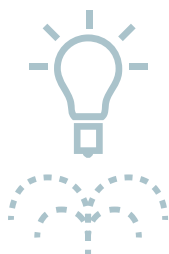

# Increasingly innovative.

The NRC systems and Nice Solemyo make installation of all automations both simple and economic, in new and restored buildings alike. Opera and BlueBUS simplify the installation, the programming and use of each automation.



## **Solemyo is the kit for solar power for the automation of gates, garage doors and barrier gates.**

Installable anywhere without the need for connections or excavations, even in the most remote locations or those difficult to access with the power mains.

Increased savings and respect for the environment thanks to solar energy, free and clean: an ecological and intelligent choice with short term benefits.

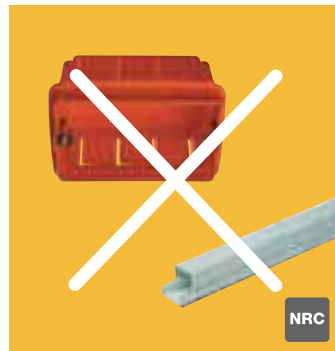

## **The NRC systems (Nice Radio Connection),**

avoiding the cost effort of building work or the installation of unsightly ducting for routing control cables make the installation of any automation much simpler and economical, in new buildings, and all renovated constructions.



## **Opera marks the future of the automation.**

The innovative system Nice Opera makes the work for the installer easier thanks to the remote control of any automation system via PC and PDA, while customers can manage home automation via Bluetooth, GSM or GPRS.



## **Easy and quick installations, just two wires without polarity!**

With Nice's revolutionary BlueBUS system far fewer connections are required, which means incredible time savings: just two wires, which carry both the communication signals and the power supply! With BlueBUS you don't need to observe any polarity, therefore any related risk factor is eliminated.



## **SYKCE**

The kit contains the photovoltaic panel **SYP** that converts sunlight into electricity and the battery box **PSY24** storing the electrical energy produced by the panel, with continuous and permanent supply throughout the day.

# Nice Selection guide

Follow the arrow and choose the right product

Irreversible, built-in control unit,  
with BlueBUS technology  
and incorporated flashing light.  
Compatible for operation  
with Solemyo and Opera.

**X-Bar**  
pages 6/7

modular pole in three  
1-metre sections with  
protective rubber strips

galvanised steel, painted case

**X-BAR**

Irreversible,  
with built-in control unit  
and magnetic encoder.  
**Signo**  
pages 8/11

bar length up to 3 m  
minimum opening time: 1.8 s

galvanised steel, painted case

**SIGNO3**

satin stainless steel case

**SIGNO3I**

bar length up to 4 m  
minimum opening time: 3 s

galvanised steel, painted case

**SIGNO4**

satin stainless steel case

**SIGNO4I**

bar length up to 6 m  
(8.5 m with accessory),  
minimum opening time: 6 s

galvanised steel, painted case

**SIGNO6**

satin stainless steel case

**SIGNO6I**

Irreversible,  
with built-in control unit.  
**Wil**  
pages 12/15

bar length up to 4 m,  
minimum opening time: 3.5 s

galvanised steel, painted case

**WIL4**

satin stainless steel case

**WIL4I**

bar length up to 6 m  
(8 m with accessory),  
minimum opening time: 5 s

galvanised steel, painted case

**WIL6**

satin stainless steel case

**WIL6I**

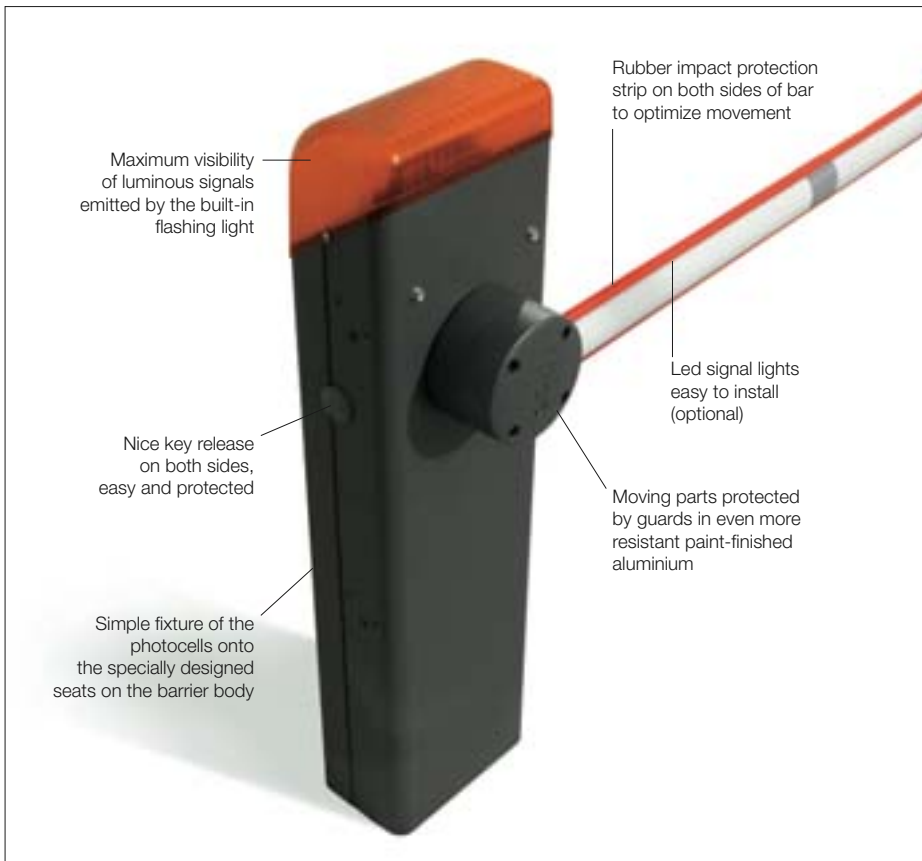

**The first electromechanical barrier gate in kit form for control of road access.**

24 Vdc gear motor, control unit, with Nice BlueBUS technology and built-in flashing light.

**Compatible for operation with Solemyo and Opera systems.**

**Powerful and fast:** electromechanical gear motor 24 Vdc, 100 W with power up to 100 Nm of torque.

**Flexible and easy to transport:** modular pole in three 1-metre sections to adapt length to the specific installation environments; including joints and cap. The compact dimensions of packaging facilitate the transport of X-Bar.

**More comfort and safety in programming and maintenance phases:** the separate enclosures for electronics and mechanics prevent internal parts from being subject to potential hazards.

**Built-in control unit,** with flashing light to guarantee optimal visibility of the luminous signal.

**More safety and reliability:** obstacle detection and monitoring of motor absorption during automation movement.

**Energy saving:** when the system is not used it sets to standby, thereby reducing consumption.

Automatic fault diagnostics during operation and consequent information on type via different combinations of flashes.

With provision for connection of the latest generation of optical and resistive sensitive edges (with 8.2 KOhm resistance).

Rapid and easy access to the control unit located in the upper section of the barrier body.

Simple fixture of the photocells onto the specially designed seats on the barrier body.

**No black out:** operation in the event of a power failure with optional batteries (PS124) housed inside the motor.

Code	Description
<b>X-BAR</b>	Irreversible 230 Vac, 24 Vdc motor. Modular pole in three 1-metre sections with rubber protection strips; enclosure in galvanized and paint-finished steel

**Technical specifications**

Code	X-BAR
<b>Electrical data</b>	
Power supply (Vac 50 Hz)	230
Absorption (A)	0.7
Power (W)	100
Built-in capacitor (µF)	-
<b>Performance data</b>	
Speed (s)	< 4
Torque (Nm)	100
Work cycle (cycles/hour)	100
<b>Dimensional and general data</b>	
Protection level (IP)	44
Working temp. (°C Min/Max)	-20 ÷ +50
Dimensions (mm)	300x179.5x1146 h
Weight (kg)	40

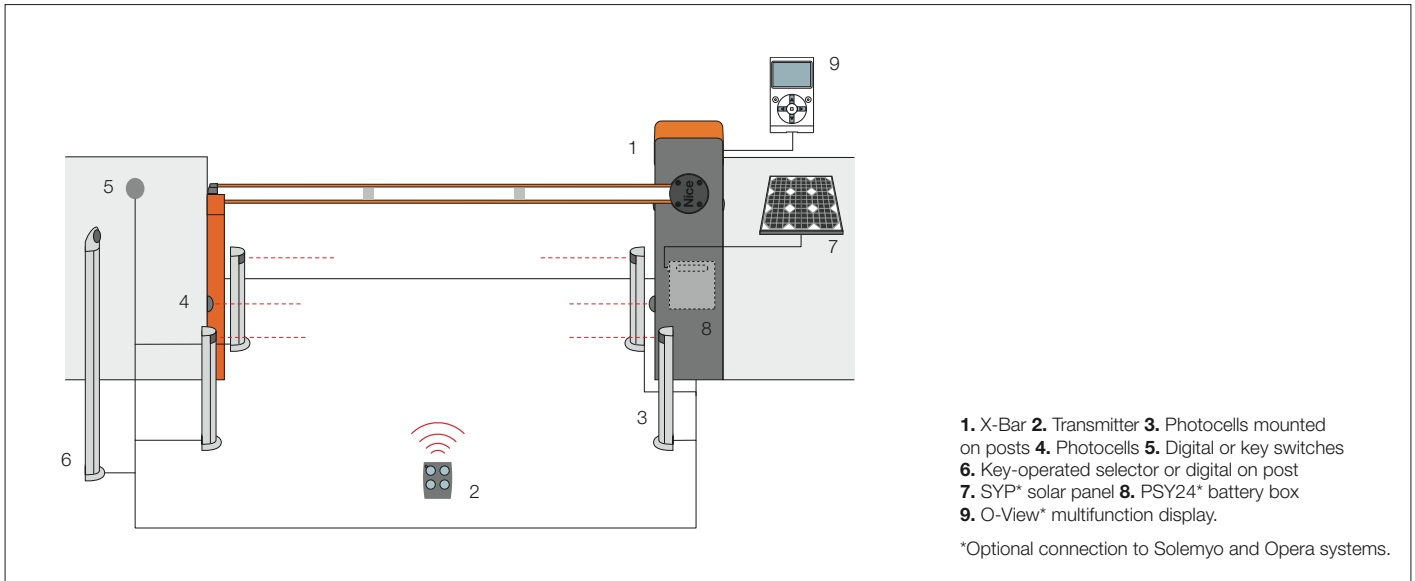

### Accessories



**XBA2**  
Spare control unit for X-BAR.  
Pc/pack 1



**PS124**  
24 V battery with integrated battery charger.  
Pc/pack 1



**SIA1**  
Anchorage base with clamps.  
Pc/pack 1



**XBA4**  
Indicator lights for click fixture of X-BAR on upper or lower side of pole.  
Pc/pack 1



**WA10**  
Red adhesive reflector strips.  
Pc/pack 24



**WA11**  
Adjustable stand for bars.  
Pc/pack 1

### Solemyo system



The solar power kit Solemyo to automate gates, garage doors or barrier gates, including those located far from the power mains and without the need for costly and invasive excavation work.

### Opera system



The innovative Opera system enables the installer to manage, program and control automation systems, also remotely, simply and safely, with significant savings in time.



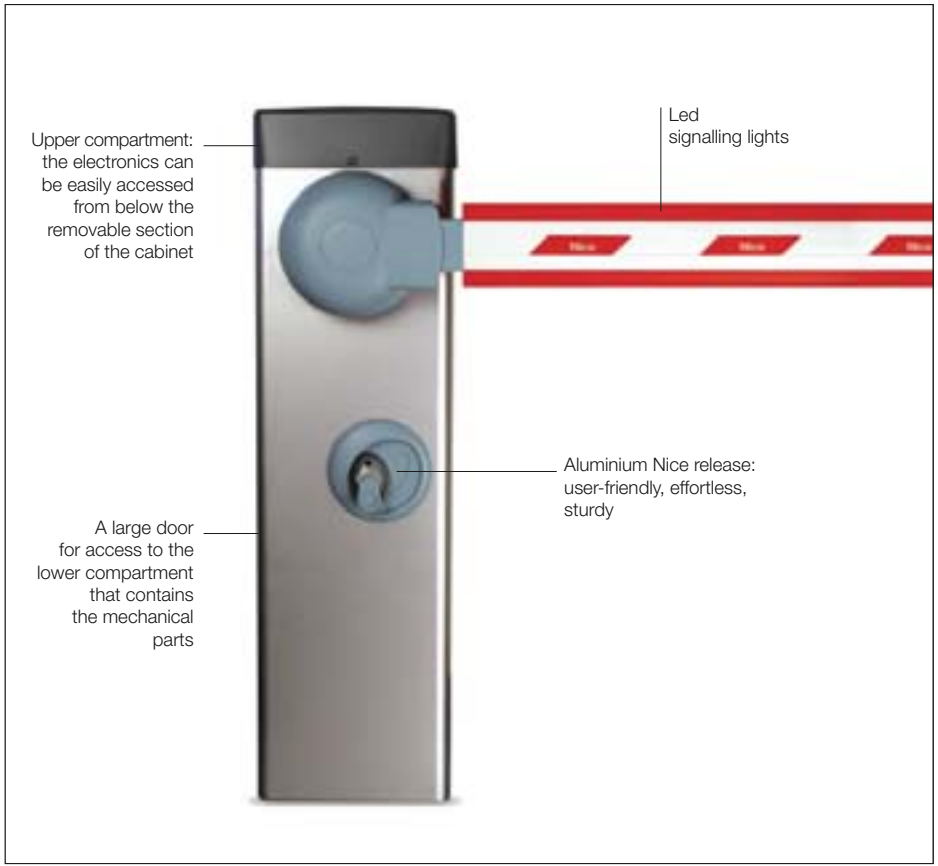

**For private, public and industrial car parks.**

Electromechanical barrier gate operator with encoder.

**Powerful and quick:** electromechanical 24 Vdc gear motor, 500 W power and up to 250 Nm torque. It opens up completely (90°) in just 1.8 seconds (Signo3), 3 seconds (Signo4), 6 seconds (Signo6). Models with a 230 Vac or 110 Vac power supply.

**Even more sophisticated and well-developed new control unit:**

The same for all models, it automatically recognises and memorises the Signo model on which it is installed thereby eliminating the first installation procedure. Signals that the power supply is correct when started and that the control unit is functioning correctly. Automatic diagnostics during operation, with differentiated visual signals according to the type of fault.

**Intelligent:** the manoeuvre will invert automatically if the bar comes into contact with an obstacle. The control unit automatically corrects any eventual lack of balance linked to variations in the climate or poor installation.

**Safe:** the innovative control unit utilises a revolutionary management system of the force, speed, acceleration and deceleration that can be **programmed at 6 levels**, at the beginning and at the end of the manoeuvre. Programming is intuitive and completely automatic with the Nice Encoder technology: Simply push a button and Signo will comprehend the limit switch limits.

**Large openings:** a master/slave selection automatically synchronises two opposing barriers enabling the automation of transit points up to 8 and 12 m.

**Convenient:** separate compartments for electronics and mechanics provide the user with easy access without damages to internal parts.

- Exclusive functions:**
- the barrier will close immediately after the vehicle has passed through;
  - it has two types of traffic-light type signals;
  - there is an automatic safety test at the beginning of each manoeuvre;
  - constant resistance STOP input for connecting the latest generation of sensitive edges;
  - there is a manoeuvre counter and it is possible to programme the maintenance alarm threshold.

**Intensive use**  
The new, 24 Vdc gear motor Signo can be used intensively for long periods of time. This characteristic makes it ideal for automating private, public or industrial car-parks which are subjected to the frequent passage of vehicles during the day.

Code	Description
<b>SIGNO3</b>	For bars up to 3 m, irreversible 230 Vac, 24 Vdc motor, with galvanised steel painted case
<b>SIGNO3I</b>	For bars up to 3 m, irreversible 230 Vac, 24 Vdc motor, with satin stainless steel case
<b>SIGNO4</b>	For bars up to 4 m, irreversible 230 Vac, 24 Vdc motor, with galvanised steel painted case
<b>SIGNO4I</b>	For bars up to 4 m, irreversible 230 Vac, 24 Vdc motor, with satin stainless steel case
<b>SIGNO6</b>	For bars up to 6 m, irreversible 230 Vac, 24 Vdc motor, with galvanised steel painted case
<b>SIGNO6I</b>	For bars up to 6 m, irreversible 230 Vac, 24 Vdc motor, with satin stainless steel case

**Technical specifications**

Code	SIGNO3 - SIGNO3I	SIGNO4 - SIGNO4I	SIGNO6 - SIGNO6I
<b>Electrical data</b>			
Power supply (Vac 50 Hz)	230		
Absorption (A)	1.1	1.3	1.3
Power (W)	300	300	500
Built-in capacitor (µF)	-		
<b>Performance data</b>			
Min. ÷ max. opening time (s)	1.8 ÷ 4	3 ÷ 6	6 ÷ 10
Torque (Nm)	130	200	250
Work cycle (cycles/hour)	600	400	250
<b>Dimensional and general data</b>			
Protection level (IP)	44		
Working temp. (°C Min/Max)	-20 ÷ +50		
Dimensions (mm)	320x200x1070 h		420x220x1070 h
Weight (kg)	50	58	

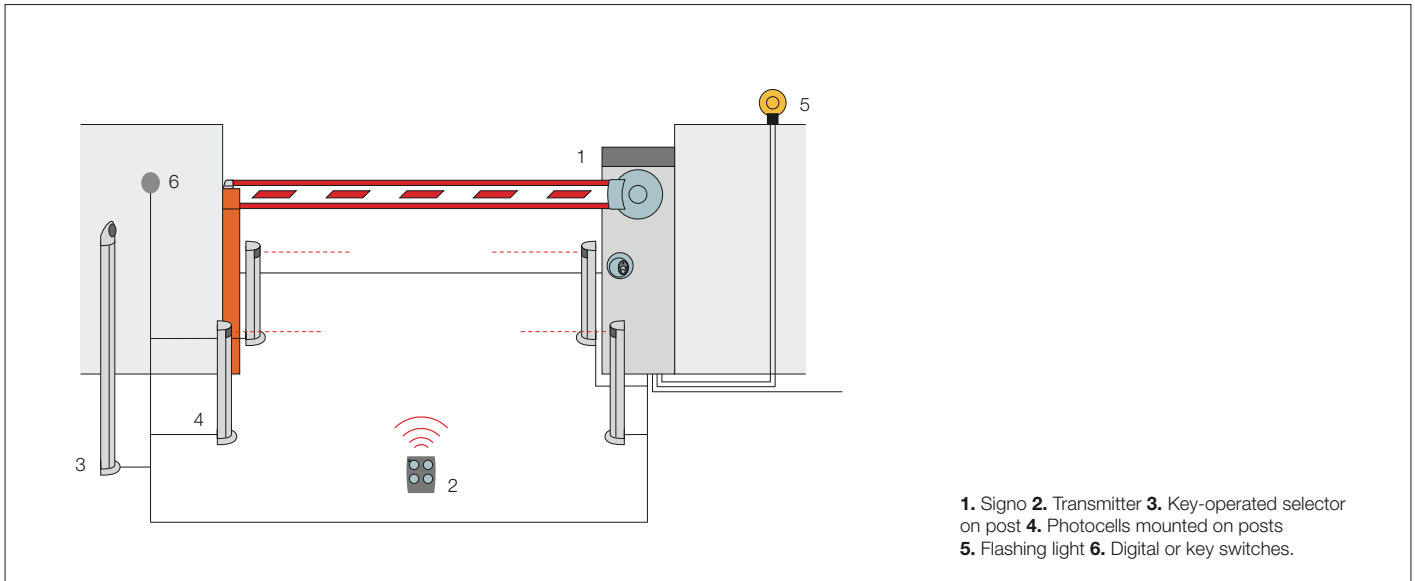

**1.** Signo **2.** Transmitter **3.** Key-operated selector on post **4.** Photocells mounted on posts **5.** Flashing light **6.** Digital or key switches.

**Utilisation limits**

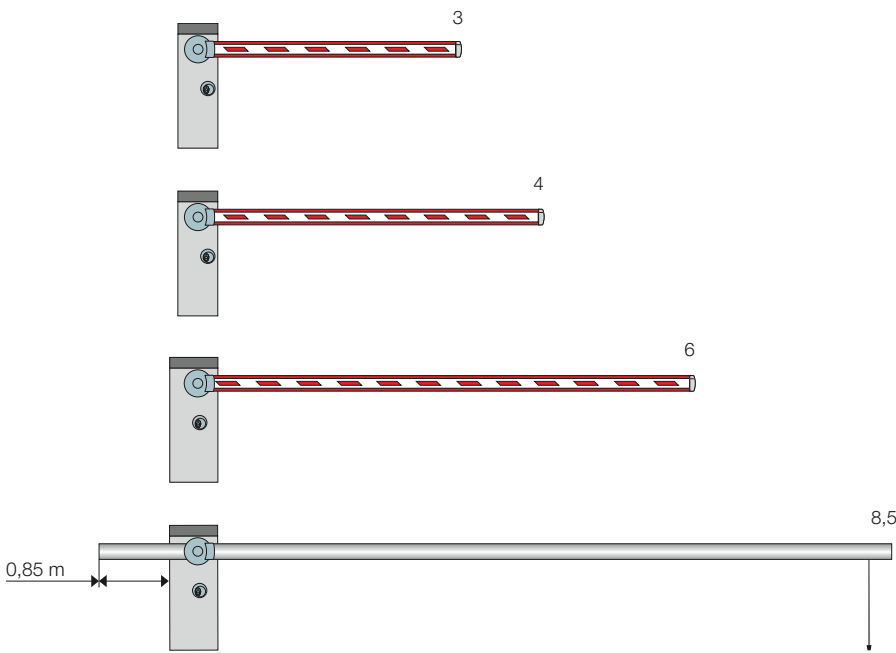

**SIGNO3 / SIGNO3l up to 3 m**  
fully accessoried bar without rack and mobile stands, with limits to speed.

**SIGNO4 / SIGNO4l up to 4 m**  
fully accessoried bar up to 3.75 m.

**SIGNO6 / SIGNO6l up to 6 m**  
bar with complete set of accessories with limits to speed.

**SIGNO6 / SIGNO6l up to 8.5 m**  
with WA24 (bar) without accessories, equipped with mobile stand, with limits to speed.

**Bar lenght (m)**

Tubular aluminium bars don't need the use of accessories (only WA11).

## Accessories for SIGNO3 / SIGNO3I



**SIA3**  
Aluminium bar, painted white 36x73x3250 mm.  
Pc/pack 1



**WA25**  
Pivoting connection for rectangular bars up to 4 m.  
Pc/pack 1



**WA2**  
8 m pack of red shockproof rubber strip with caps to close SIA3 bar.  
Pc/pack 1



**SIA1**  
Anchorage base with clamps.  
Pc/pack 1

## Accessories for SIGNO4 / SIGNO4I



**WA1**  
Aluminium bar, painted white 36x73x4250 mm.  
Pc/pack 1



**WA25**  
Pivoting connection for rectangular bars up to 4 m.  
Pc/pack 1



**WA2**  
8 m pack of red shockproof rubber strip with caps to close WA1 bar.  
Pc/pack 1



**WA13**  
Aluminium rack (2 m) for WA1, WA21, WA22 bars.  
Pc/pack 1



**WA14**  
Joint for rods WA1 (from 1950 mm to 2400 mm).  
Pc/pack 1



**WA3**  
Tubular aluminium bar, painted white Ø 70x4250 mm, suitable where there are strong winds. Only with WA11.  
Pc/pack 1



**WA4**  
Connection for the WA3 bar.  
Pc/pack 1



**SIA1**  
Anchorage base with clamps.  
Pc/pack 1

## Accessories for SIGNO6 / SIGNO6I



**WA21**  
Aluminium bar, painted white 36x94x6250 mm.  
Pc/pack 1

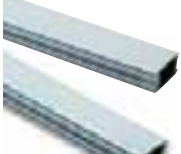

**WA22**  
Modular bar, plus joint painted white, 2 sections 36x94x3125 mm.  
Pc/pack 2



**WA6**  
Pack 12 m of red shockproof rubber strip with caps to close the bars WA21, WA22.  
Pc/pack 1



**WA24**  
Tubular telescopic bar in white painted aluminium, max. length 8.5 m, complete with mobile support WA12, counterweight and connector. 6 meters overall length for transportation. See draft page 9.  
Pc/pack 1



**WA7**  
Tubular aluminium bar, painted white Ø 90x6250 mm suitable where there are strong winds, only with WA11.  
Pc/pack 1

**Accessories for SIGNO6 / SIGNO6I**



**WA8**  
Connection  
for the WA7 bar.  
Pc/pack 1



**WA13**  
Aluminium rack (2 m)  
for WA1, WA21, WA22  
bars.  
Pc/pack 1



**SIA2**  
Anchorage base  
with clamps.  
Pc/pack 1

**Common accessories**



**SIA20**  
Spare control unit.



**PS224**  
24 Vdc buffer battery.  
Pc/pack 1



**WA9**  
Pack of 6 flashing signals,  
wired for WA1, WA21,  
WA22 bars.  
Pc/pack 6



**WA10**  
Red adhesive  
reflector strips.  
Pc/pack 24



**WA11**  
Adjustable stand  
for bars.  
Pc/pack 1



**WA12**  
Mobile stand  
for bars.  
Pc/pack 1



**PO**  
Support bracket  
for photocells Bf, FE.  
Pc/pack 4

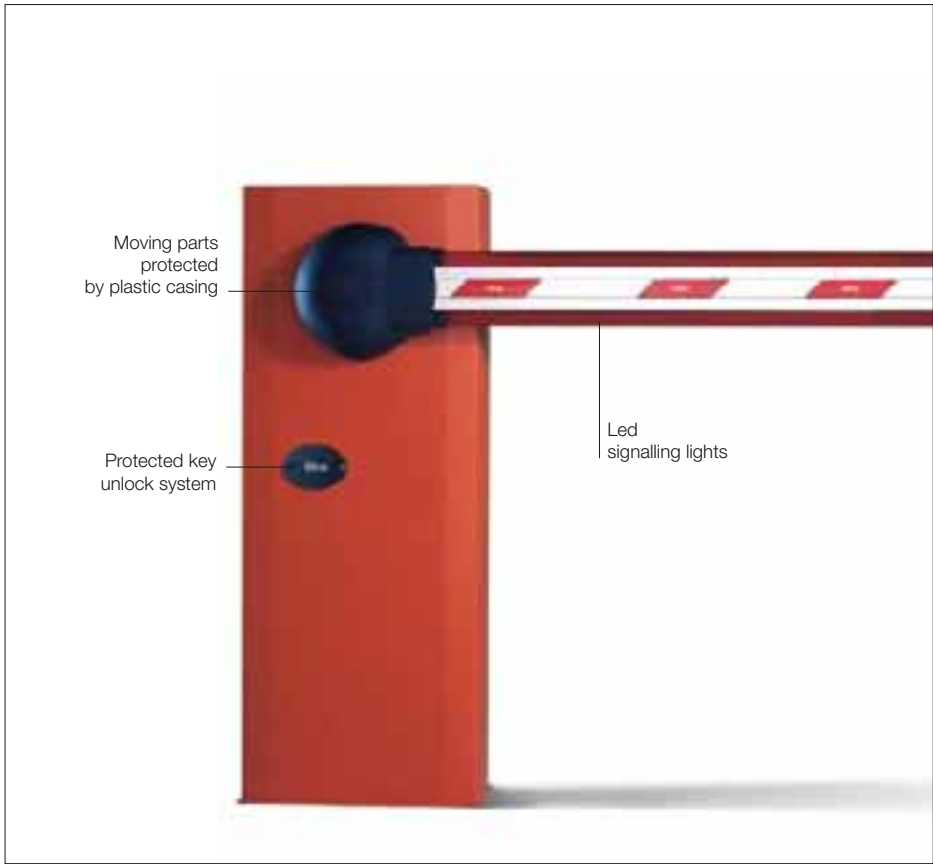

**For private, public and industrial car parks.**

Electromechanical barrier gate, 24 Vdc, with adjustable speed and anti-crushing safety feature. Intensive use.

**Four versions:**  
**up to 4 m** (WIL4, WIL4I),  
**up to 6 m** (WIL6, WIL6I).

**Galvanised steel, painted case or AISI 304** (WIL4I, WIL6I).

**Incorporated control unit**, can be removed, making wiring and maintenance easier.

**Easy to install:** the bar can be assembled on either the right or left hand side indifferently.

**Easy to balance:** linear adjustment of the spring.

**The system will operate during a blackout** by means of internally fitted, rechargeable batteries.

The limit switches for slowdown during both opening and closing can be adjusted both mechanically and electronically.

**Speed can be electronically adjusted:** WIL4, 3.5 second minimum opening time; WIL6, 5 second opening time.

**Anti-crush safety feature** on opening and closing.

**Painted aluminium bar profile:** easy to assemble the signalling lights and pneumatic edge.

**Led signalling lights:** highly efficient and long-lasting.

**Protected simple key-operated release.**

Code	Description
<b>WIL4</b>	For bars up to 4 m, irreversible 230 Vac, 24 Vdc motor, with galvanised steel painted case
<b>WIL4I</b>	For bars up to 4 m, irreversible 230 Vac, 24 Vdc motor, with satin stainless steel case
<b>WIL6</b>	For bars up to 6 m, irreversible 230 Vac, 24 Vdc motor, with galvanised steel painted case
<b>WIL6I</b>	For bars up to 6 m, irreversible 230 Vac, 24 Vdc motor, with satin stainless steel case

**Technical specifications**

Code	WIL4 - WIL4I	WIL6 - WIL6I
<b>Electrical data</b>		
Power supply (Vac 50 Hz)	230	
Absorption (A)	1.1	0.6
Power (W)	300	360
Built-in capacitor (µF)	-	
<b>Performance data</b>		
Minimum opening time (s)	3.5	5
Torque (Nm)	140	200
Work cycle (%)	80	
<b>Dimensional and general data</b>		
Protection level (IP)	54	
Working temp. (°C Min/Max)	-20 ÷ +50	
Dimensions (mm)	320x220x1000 h	420x220x1050 h
Weight (kg)	46	54

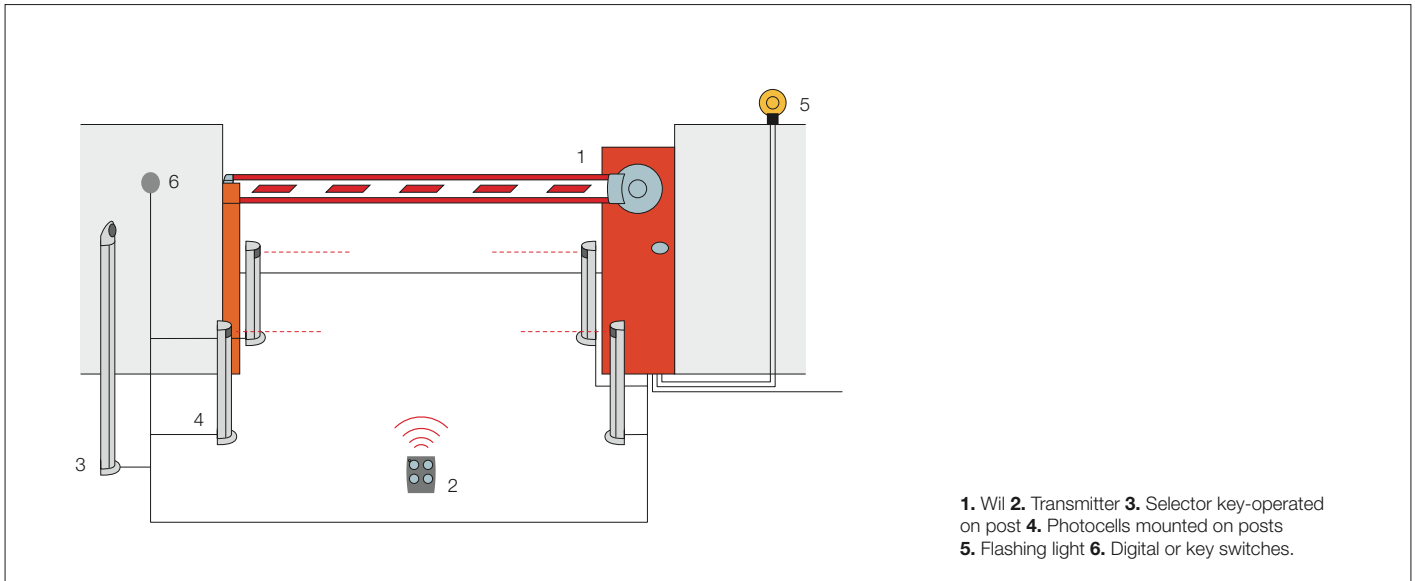

### Utilisation limits

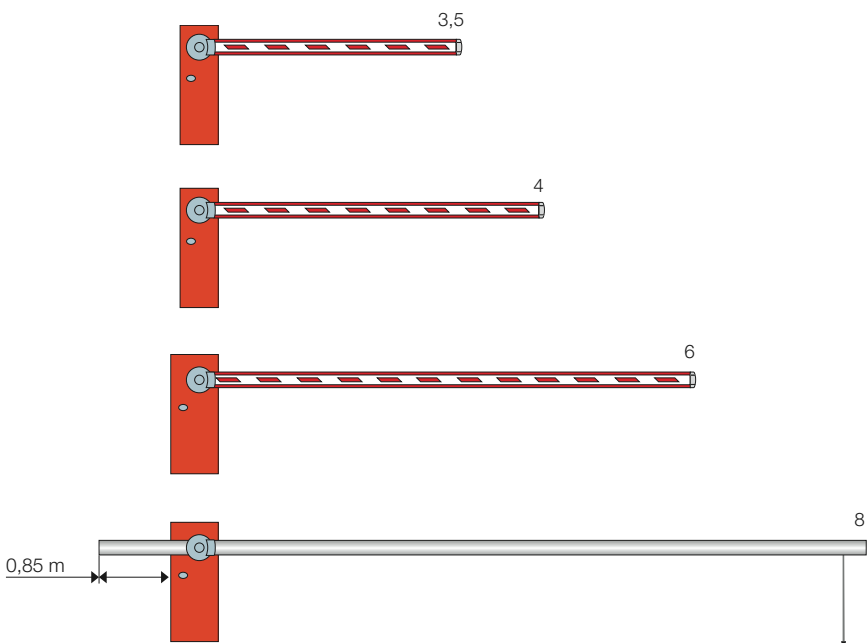

**WIL4 / WIL4I up to 3.5 m**  
fully accessoried bar  
without speed limit.

**WIL4 / WIL4I up to 4 m**  
fully accessoried bar with speed limit  
and a WA13 rack max lenght of 2 m  
**or**  
4 m rack lenght without shockproof  
rubber strip WA2.

**WIL6 / WIL6I up to 6 m**  
fully accessoried bar with speed limit  
and a WA13 rack max lenght of 4 m  
**or**  
WA13 rack lenght 6 m,  
without shockproof rubber strip WA2.

**WIL6 / WIL6I up to 8 m**  
with WA24 (bar without accessories),  
with no limits to speed.

### Bar lenght (m)

Tubular aluminium bars don't need the use of accessories (only WA11).

## Accessories for WIL4 / WIL4I



**WA1**  
Aluminium bar, painted white 36x73x4250 mm.  
Pc/pack 1



**WA25**  
Pivoting connection for rectangular bars up to 4 m.  
Pc/pack 1



**WA2**  
8 m pack of red shockproof rubber strip with caps to close WA1 bar.  
Pc/pack 1



**WA14**  
Joint for rods WA1 (from 1950 mm to 2400 mm).  
Pc/pack 1



**WA3**  
Tubular aluminium bar, painted white Ø 70x4250 mm, suitable where there are strong winds only with WA11.  
Pc/pack 1



**WA4**  
Connection for the WA3 bar.  
Pc/pack 1



**WA15**  
Anchorage base with clamps.  
Pc/pack 1

## Accessories for WIL6 / WIL6I



**WA21**  
Aluminium bar, painted white 36x94x6250 mm.  
Pc/pack 1



**WA22**  
Modular bar, plus joint painted white, 2 sections 36x94x3125 mm.  
Pc/pack 2



**WA6**  
Pack 12 m of red, shockproof, rubber strip with caps to close the bars WA21, WA22.  
Pc/pack 1



**WA24**  
Tubular telescopic bar in white painted aluminium, max. length 8 m, complete with mobile support WA12, counterweight and connector. 6 m overall length for transportation. See draft page 13.  
Pc/pack 1



**WA7**  
Tubular aluminium bar, painted white Ø 90x6250 mm suitable where there are strong winds, only with WA11.  
Pc/pack 1



**WA8**  
Connection for the WA7 bar.  
Pc/pack 1



**WA16**  
Anchorage base with clamps.  
Pc/pack 1

**Common accessories**



**WA20**  
Spare control unit.



**CARICA**  
Plug-in card  
for battery charger.  
Pc/pack 1



**B12-B**  
12 V, 6 Ah batteries.  
Pc/pack 1



**WA9**  
Pack of flashing signals,  
wired for WA1, WA21,  
WA22 bars.  
Pc/pack 6



**WA10**  
Red adhesive  
reflector strips.  
Pc/pack 24



**WA13**  
Aluminium rack (2 m)  
for WA1, WA21, WA22  
bars.  
Pc/pack 1



**WA11**  
Adjustable stand  
for bars.  
Pc/pack 1



**WA12**  
Mobile stand  
for bars.  
Pc/pack 1



**PO**  
Support bracket  
for photocells Bf, FE.  
Pc/pack 4

# Nice control electronics

## **With just a click!**

Small, slim and coloured, ideal to carry in your pocket, bag or use as stylish key rings, or table-top or wall-mounted, for control the entire home at your fingertips!



## NiceWay: many solutions, just one gesture.



Table shockproof holder.



Wall or table shockproof holder.

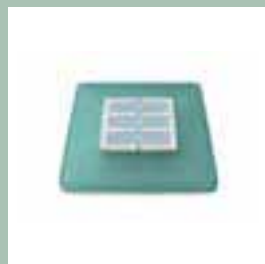

Squared wall plate.



Rectangular wall plate.



Module holder cover.

## Transmitters



**One**  
433.92 MHz and 868.46 MHz transmitters, with management of Identity Codes and Certificates. Compatible with Opera System. 1, 2, 4 and 9 channel versions.

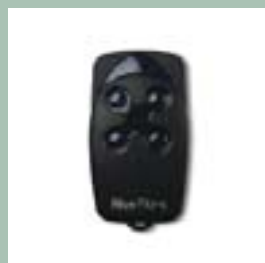

**FloR**  
Radio-control 433.92 MHz rolling code system with self-learning function. 1, 2 and 4 channels versions.



**Very**  
Miniaturised radio control 433.92 MHz rolling code system with self-learning function or programmable code.



**Smilo**  
Radio-controls 433.92 MHz rolling code system with self-learning function. 2 and 4 channel versions.

## Tag system



Disappearing inside standard wall mounted plates and suitable to confined spaces, are ideal for restorations and upgrades of existing systems to control home automations, lighting points and all loads up to 500 W not directly accessible from cable controls.

All without the need to replace the existing system or involve building work!

## Control units



### Moonclever and Mindy

Range of Nice control units: all kinds of models for all kinds of automations, from the simplest to the most sophisticated, which offer exclusive, fully-developed functions by means of magnetic encoders.

New Moonclever **MC824H**, the innovative control unit with magnetic encoder for motors 24 Vdc, equipped with BlueBUS technology and designed for operation with the systems Solemyo and Opera.

## Accessories



### Moon

Range of digital and key switches, proximity sensor reader for transponder card and synchronised photocells with a 10° receiving angle, also available in a 30° version adjustable, with BlueBUS technology.



### F210

Synchronised photocells adjustable at 210° horizontally, with relay output or BlueBUS technology.



### FT210

Optical device adjustable at 210° horizontally and 30° vertically. With relay output or BlueBUS technology.



### Moonlight and Wallyght

Modular flashing signal light and multi-function Led indicator.

## System Opera



**Nice Opera simplifies the installer's work, making for easier programming,** and enabling access to all control panel parameters to adapt the system to all requirements. No specific procedures needed for each product: single programming mode with intuitive menus, with no need to consult instructions. Thanks to the GSM module, diagnostics can be performed remotely and the automation can be monitored constantly avoiding costly inspections on site with significant savings in time.

**The BUS T4 technology enables the creation of a network of devices,** connecting compatible control units between them, and centralising control via O-View. By interfacing the system with the PC, you can control a complex automation system such as those found in densely frequented buildings (hospitals, hotels, companies, etc.).

**Management of the One series transmitters,** even in large numbers, **is now fast and simple** with the option for remote control, and the creation of a database thanks to the software supplied.



**One**  
Transmitters  
and receivers



**O-View**  
Multifunction  
display



**O-Box**  
Connection interface



**OX4T**  
Universal  
receiver

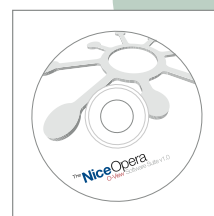

**O-View\_O-Box  
Software Suite**  
Communication  
software for PC  
and PDA



## Certified quality

Safety, quality, reliability and durability are priorities for Nice. All Nice Products in fact comply with the provisions of the **European Directives** governing construction.

## Service

Dealers who offer Nice products to their customers believe in the value of quality; providing service that satisfies all the needs and wishes of customers, before and after sales, is a duty. Contact a Nice specialist with complete trust!



NiceLoveEarth

Nice cares for the environment. Using natural paper it avoids excessive use of raw materials and forest exploitation. Waste is reduced, energy is saved and climate quality is improved.

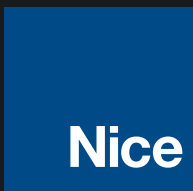
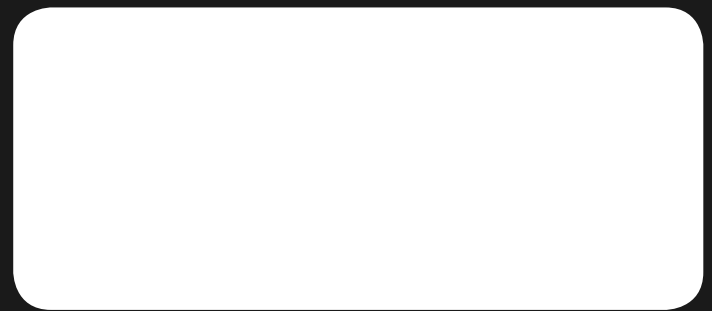

**Nice SpA**  
Oderzo TV Italia  
Ph. +39.0422.85.38.38  
Fax +39.0422.85.35.85  
info@niceforyou.com

Find out more about Nice products and services on the website:  
**www.niceforyou.com**